

PRODUCT CODE: CL108P-115WM-PFCN

8 INCH APERTURE CLOSET LIGHT SURFACE MOUNT 3CCT

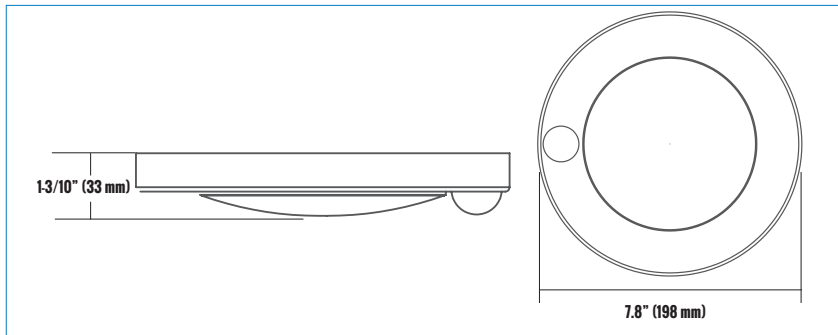

### PRODUCT DESCRIPTION

The new Etlin-Daniels Low Profile LED Closet Light CL108P-115WM-PFCN offers the latest in compact design, energy savings, lumen performance, and auto on/off with a built-in and improved range PIR Sensor. At only 1-1/3" in depth and 8" in width, and with an aluminum housing to dissipate what little heat the diode array may produce, and its easy-to-remove frosted polycarbonate lens, the new CL108P provides an upgrade over the previous CL106P generations. The new design with 15W and 1000lm now comes with a built-in switch that allows for the choice between 3000K, 4000K and 5000K - 3CCT. Choose whatever color temperature best enhances the application. And the new design has multiple keyless slot locations to attach to a j-box, allowing for optimal positioning of the sensor to best provide for the auto-on function. Once the space is vacated, the sensor will automatically shut off the fixture after 30 seconds.

The new CL108P design is the perfect solution to illuminate closets, garbage rooms, small storage rooms, washrooms, basements, residential garages - anywhere a typical fixture may be left on when the space is vacated. The slim housing will not impede any activity in the small space and the new 1000lm light levels will better provide proper light levels for not only storage, but also function.

### FEATURES

- LED Indoor Light Source
- Surface Mount low profile 1-1/3" housing.
- Durable Aluminum body with frosted polycarbonate lens.
- 3CCT - choose between 3000K, 4000K or 5000K.
- 120° beam spread.
- Wet location rated.
- Keyless slot mounting to j-box.
- PIR Sensor built-in - 30 second to off once space is vacated.
- 5 year warranty.
- L70 - 50,000 hours.
- Energy Star certified.

### PRODUCT SPECIFICATIONS (OPTICAL DATA)

### PRODUCT SPECIFICATIONS (ELECTRICAL DATA)

SYSTEM EFFICACY	LUMENS	COLOR TEMPERATURE	CRI	VOLTAGE	POWER FREQ.
3000K = 66.4LM/W 4000K = 78.62LM/W 5000K = 68.12LM/W	3000K = 996.502 LM 4000K = 1179.26 LM 5000K = 1021.81 LM	CHANGEABLE: 3000K / 4000K / 5000K	>80CRI	120VAC	60HZ

### PRODUCT SPECIFICATIONS

WATTAGE	FIXTURE MATERIAL	LIFE SPAN	PRODUCT DIMENSIONS	CARTON SIZE
15W	PC PLASTIC / METAL	>50,000 HOURS	7.8 x 1 INCHES (198 x 33 MM)	6.125 X 6.125 X 1.375 INCHES (155 X 155 X 35 MM)



### ADDITIONAL INFORMATION

#### INSTALLATION METHOD

#### FIXTURE COLOR/DIFFUSER

#### CONTROL TYPE

CEILING MOUNT

WHITE MATTE / FROSTED

NON-DIMMABLE  
PIR SENSOR

**PRODUCT CODE: CL108P-115WM-PFCN**
**8 INCH APERTURE CLOSET LIGHT SURFACE MOUNT 3CCT**

**LUMINAIRE PHOTOMETRIC (TEST REPORT) - 3000K**
**ILLUMINANCE (AT A DISTANCE) - FLUX OUT: 687.7LM**

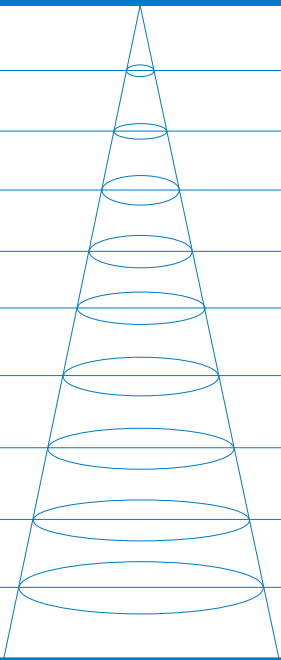
3.28FT 1M	124.3, 372.8 LX		8.63FT 263.11CM
6.56FT 2M	31.08, 93.21 LX		17.26FT 526.22CM
9.84FT 3M	13.81, 41.43 LX		25.89FT 789.33CM
13.12FT 4M	7.769, 23.30 LX		34.52FT 1052.44CM
16.40FT 5M	4.972, 14.91 LX		43.16FT 1315.55CM
19.69FT 6M	3.453, 10.36 LX		51.79FT 1578.67CM
22.97FT 7M	2.537, 7.609 LX		60.43FT 1841.78CM
26.25FT 8M	1.942, 5.826 LX		69.05FT 2104.89CM
29.52FT 9M	1.535, 4.603 LX		77.69FT 2368.00CM
32.80FT 10M	1.243, 3.728 LX		86.32FT 2631.11CM
<b>HT</b>	<b>EAVG/EMAX</b>	<b>ANGLE: 105.52 DEG</b>	<b>DIA</b>

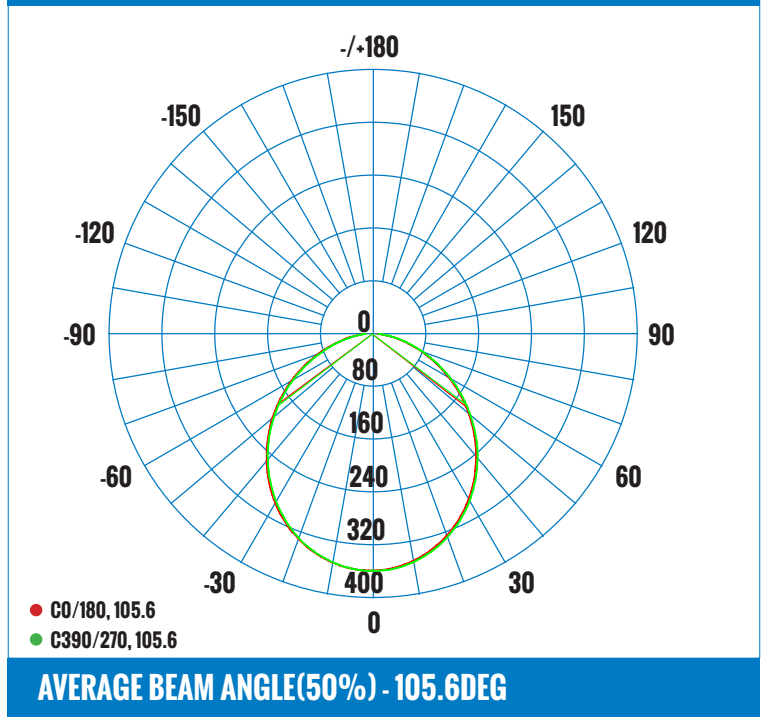
**LUMINOUS INTENSITY DISTRIBUTION DIAGRAM**

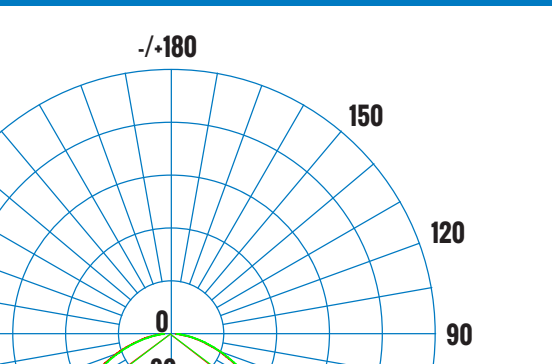
**LUMINAIRE PHOTOMETRIC (TEST REPORT) - 4000K**
**ILLUMINANCE (AT A DISTANCE) - FLUX OUT: 813.7LM**

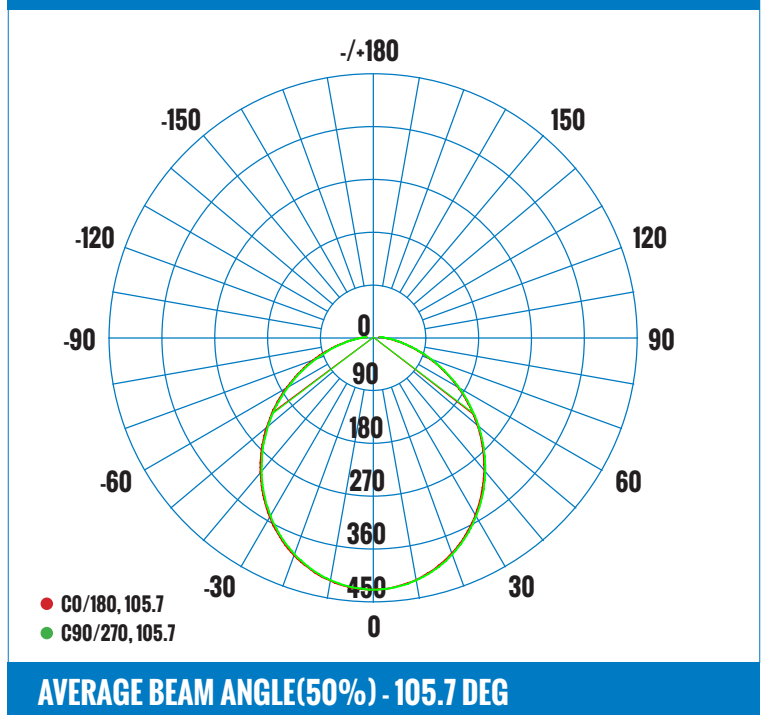
3.28FT 1M	147.1, 440.4 LX		8.66FT 263.83CM
6.56FT 2M	36.77, 110.11 LX		17.31FT 527.65CM
9.84FT 3M	16.34, 48.94 LX		25.97FT 791.48 CM
13.12FT 4M	9.192, 27.53 LX		34.62FT 1055.31 CM
16.40FT 5M	5.883, 17.62 LX		43.27FT 1319.13 CM
19.69FT 6M	4.085, 12.23 LX		51.93FT 1582.96 CM
22.97FT 7M	3.001, 8.988 LX		60.59FT 1846.79 CM
26.25FT 8M	2.298, 6.882 LX		69.24FT 2110.62 CM
29.52FT 9M	1.816, 5.437 LX		77.90FT 2374.44 CM
32.80FT 10M	1.471, 4.404 LX		86.56FT 2638.27 CM
<b>HT</b>	<b>EAVG/EMAX</b>	<b>ANGLE: 105.67DEG</b>	<b>DIA</b>

**LUMINOUS INTENSITY DISTRIBUTION DIAGRAM**

CATALOG #		TYPE
PROJECT		DATE
PREPARED BY		

**PRODUCT CODE: CL108P-115WM-PFCN 8 INCH APERTURE CLOSET LIGHT SURFACE MOUNT 3CCT**

**LUMINAIRE PHOTOMETRIC (TEST REPORT) - 5000K**

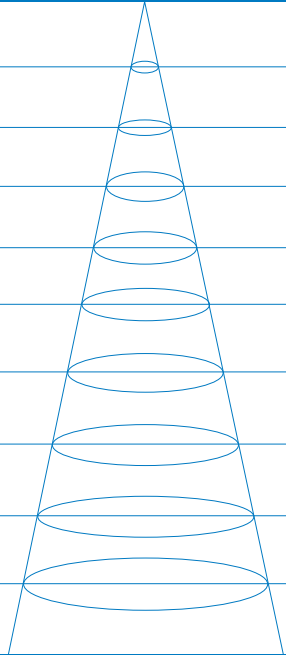
ILLUMINANCE (AT A DISTANCE) - FLUX OUT: 704.9LM			
3.28FT 1M	127.4, 381.4 LX		8.67FT 264.21 CM
6.56FT 2M	31.85, 95.34 LX		17.34FT 528.42 CM
9.84FT 3M	14.16, 42.37 LX		26.00FT 792.63 CM
13.12FT 4M	7.963, 23.83 LX		34.67FT 1056.84 CM
16.40FT 5M	5.096, 15.25 LX		43.34FT 1321.05 CM
19.69FT 6M	3.539, 10.59 LX		52.00FT 1585.26 CM
22.97FT 7M	2.600, 7.783 LX		60.67FT 1849.47 CM
26.25FT 8M	1.991, 5.959 LX		69.34FT 2113.68 CM
29.52FT 9M	1.573, 4.708 LX		78.01FT 2377.89 CM
32.80FT 10M	1.274, 3.814 LX		86.68FT 2642.10 CM
<b>HT</b>	<b>EAVG/EMAX</b>	<b>ANGLE: 105.75DEG</b>	<b>DIA</b>

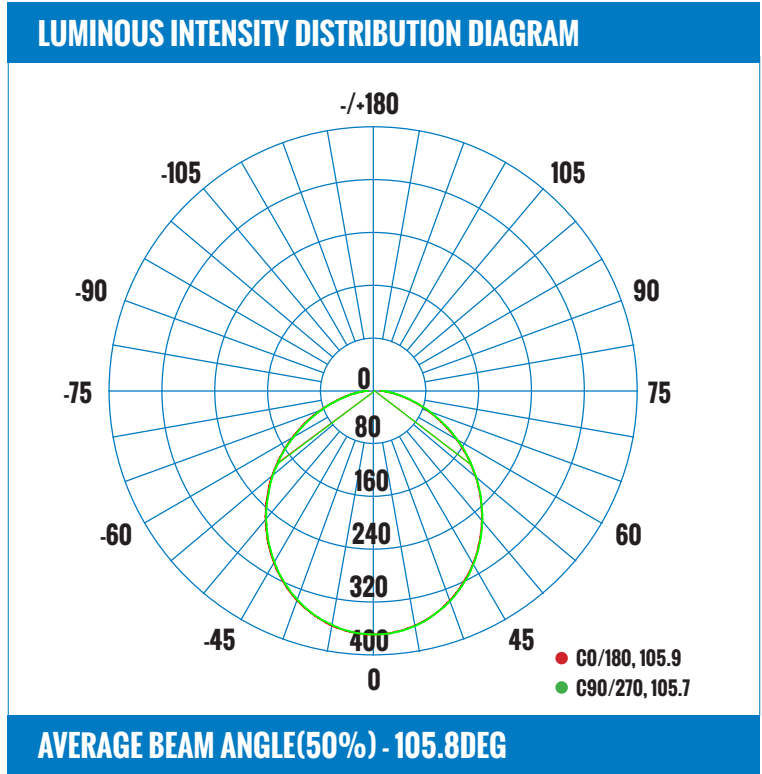

**CERTIFICATIONS**



CAN ICES-005 (B) / NMB-005 (B)

**CONTROL**



**ORDERING INFORMATION - CL SERIES**

SERIES	SIZE	CONTROL TYPE	VOLTAGE	WATTAGE	FINISH	DIFFUSER	COLOR TEMPERATURE	DIMMABLE
E.G. CL10	8	P	1	15	WM	PF	C	N
CL10 - CLOSET LIGHT	8 - 8 INCH	P - PIR SENSOR	1-120V	15-15W	WH-WHITE MATTE	PF - PC FROSTED	C -	N - NO
							COLOR CHANGEABLE:	
							3000K/4000K/5000K	

Head Office - 1850 Wilson Ave. · Toronto, ON · M9M 1A1 · Tel: 416.741.7336 · Fax: 416.741.9104

Toll Free: in Canada. 1.800.661.9610 · in USA. 1.888.762.5384 (SOCKETS4U)

www.etlin-daniels.com · For sales/service questions - sales@etlin.com