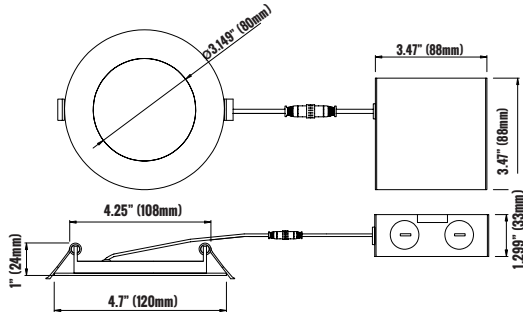

PRODUCT CODE: DLSWR4-121LCD-WH-FF
4 INCH LED ULTRATHIN DOWNLIGHT - 3CCT SERIES

PRODUCT DESCRIPTION

The new generation of Etlin-Daniels DLSWR4-121LCD-WH-FF LED Ultrathin Downlight offers a modern and sleek looking energy efficient option for both new construction and retrofit / remodelling projects. It installs easily where there is minimal ceiling space due to ductwork, joists and beams.

The new 121LCD design comes with a white trim - snap-on black and brushed nickel trims are available as options. And, to help reduce inventory stress, there is a 3CCT (Correlated Color Temperature) switch built into the exterior of the driver box for easy access when installing. 3000K, 4000K and 5000K color temps are all available.

Why waste time installing older space restrictive recessed options when the Etlin-Daniels wet location rated, 3CCT Ultrathin provides a quick install solution, and elegant, superior illumination for your residential and commercial projects?

FEATURES

- LED Indoor Light Source
- 4" LED Downlight
- Durable air-tight aluminum body
- IC Air-Tight rated
- Wet location rated (indoor)
- Elegant white paint finish
- Etched white Polycarbonate diffuser lens for glare free illumination
- 2 spring loaded clips for mounting to any ceiling material
- 3CCT switch conveniently located allows choice of 3000K - 788LM // 4000K - 903LM // 5000K - 831LM
- Default CT setting is 3000K
- Snap-on trims available in black & brushed nickel
- Triac dimmable
- 5 year warranty
- Energy Star certified

PRODUCT SPECIFICATIONS (OPTICAL DATA)

PRODUCT SPECIFICATIONS (ELECTRICAL DATA)

LED TYPE	LED QTY	SYSTEM EFFICACY	LUMENS	COLOR TEMPERATURE (CHANGEABLE)	BEAM ANGLE	CRI	SYSTEM EFFICIENCY	VOLTAGE	POWER FREQ.	POWER EFFICIENCY	POWER FACTOR	HARMONIC DISTORTION
HONGLI 2835	48 CHIPS	65.6 LM/W 75.25 LM/W 69.25 LM/W	788LM 903LM 831LM	3000K 4000K 5000K	120°	>80CRI	>0.96%	INPUT - 120VAC OUTPUT - 24 - 36VDC	50/60HZ	>80%	>0.91	26%

PRODUCT SPECIFICATIONS

WATTAGE	FIXTURE MATERIAL	LIFE SPAN	STORAGE TEMP	OPERATING TEMP	PRODUCT DIMENSIONS	CARTON SIZE
12W	ALUMINUM/ POLYCARBONATE LENS	>50,000 HOURS	-40°C~+60°C -40°F~+140°F	-30°C~+40°C -40°F~+104°F	Ø4.7 X 1 INCHES (120 X 24 MM)	5.31 X 5.31 X 2.55 INCHES (135 X 135 X 65MM)

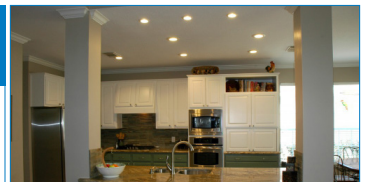

ADDITIONAL INFORMATION

INSTALLATION METHOD

RECESSED CEILING MOUNT

FIXTURE COLOR

WHITE WITH WHITE
ETCHED DIFFUSER

CONTROL TYPE

TRIAC DIMMABLE DRIVER INCLUDED

PRODUCT CODE: DLSWR4-121LCD-WH-FF
4 INCH LED ULTRATHIN DOWNLIGHT - 3CCT SERIES

LUMINAIRE PHOTOMETRIC (TEST REPORT) - 3000K
ILLUMINANCE (AT A DISTANCE) - FLUX OUT: 566.6 LM

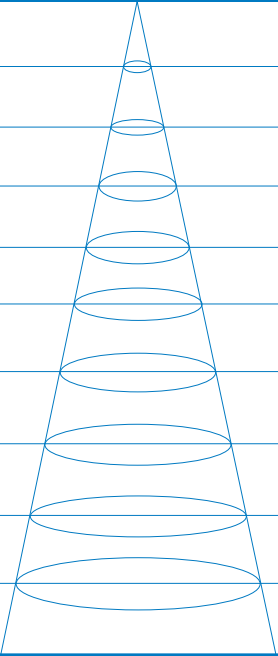
3.28FT 1M	82.05, 279.6LX		9.41FT 286.69CM
6.56FT 2M	20.51, 69.90LX		18.81FT 573.38CM
9.84FT 3M	9.116, 31.07LX		28.22FT 860.08CM
13.12FT 4M	5.128, 17.47LX		37.62FT 1146.77CM
16.40FT 5M	3.282, 11.18LX		47.03FT 1433.46CM
19.69FT 6M	2.279, 7.766LX		56.44FT 1720.15CM
22.97FT 7M	1.674, 5.706LX		65.84FT 2006.84CM
26.25FT 8M	1.282, 4.369LX		75.25FT 2293.53CM
29.52FT 9M	1.013, 3.452LX		84.65FT 2580.23CM
32.80FT 10M	0.8205, 2.796LX		94.06FT 2866.92CM
HT	EAVG/EMAX	ANGLE: 110.20DEG	DIA

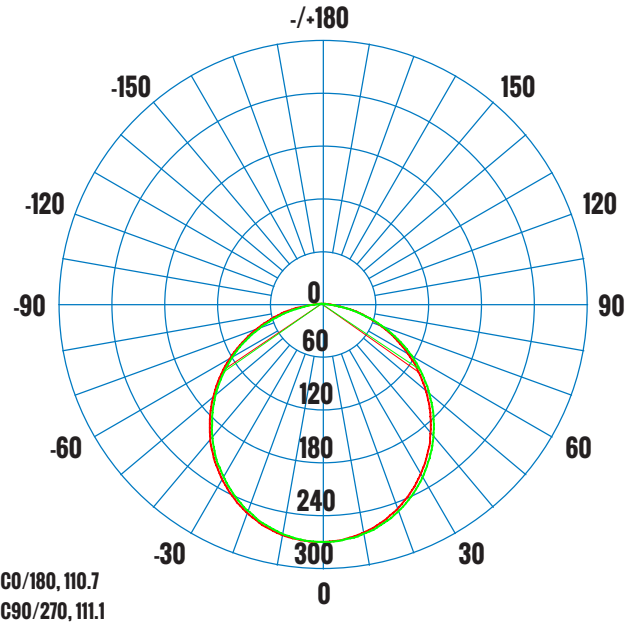
LUMINOUS INTENSITY DISTRIBUTION DIAGRAM

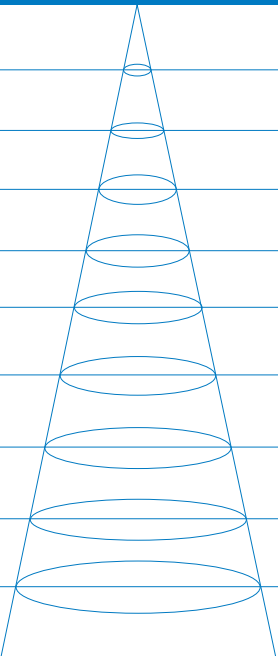
AVERAGE BEAM ANGLE(50%) - 110.9 DEG
LUMINAIRE PHOTOMETRIC (TEST REPORT) - 4000K
ILLUMINANCE (AT A DISTANCE) - FLUX OUT: 652.8LM

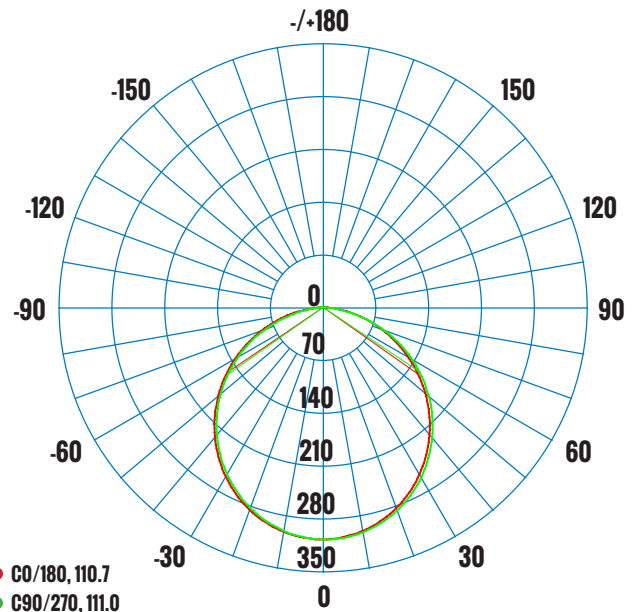
3.28FT 1M	94.53, 319.1LX		9.49FT 289.21CM
6.56FT 2M	23.63, 79.77LX		18.98FT 578.42CM
9.84FT 3M	10.50, 35.45LX		28.47FT 867.64CM
13.12FT 4M	5.908, 19.94LX		37.95FT 1156.85CM
16.40FT 5M	3.781, 12.76LX		47.44FT 1446.06CM
19.69FT 6M	2.626, 8.863LX		56.93FT 1735.27CM
22.97FT 7M	1.929, 6.512LX		66.42FT 2024.48CM
26.25FT 8M	1.477, 4.986LX		75.91FT 2313.70CM
29.52FT 9M	1.167, 3.939LX		85.4FT 2602.91CM
32.80FT 10M	0.9453, 3.191LX		94.89FT 2892.12CM
HT	EAVG/EMAX	ANGLE: 110.67DEG	DIA

LUMINOUS INTENSITY DISTRIBUTION DIAGRAM

AVERAGE BEAM ANGLE(50%) - 110.9 DEG

CATALOG #		TYPE
PROJECT		DATE
PREPARED BY		

PRODUCT CODE: DLSWR4-121LCD-WH-FF

4 INCH LED ULTRATHIN DOWNLIGHT - 3CCT SERIES

LUMINAIRE PHOTOMETRIC (TEST REPORT) - 5000K

ILLUMINANCE (AT A DISTANCE) - FLUX OUT: 590.9 LM

3.28FT 1M	85.57, 288.9LX		9.51FT 289.75CM
6.56FT 2M	21.39, 72.21LX		19.01FT 579.50CM
9.84FT 3M	9.508, 32.10LX		28.52FT 869.26CM
13.12FT 4M	5.348, 18.05LX		38.03FT 1159.01CM
16.40FT 5M	3.423, 11.55LX		47.53FT 1448.76CM
19.69FT 6M	2.377, 8.024LX		57.03FT 1738.51CM
22.97FT 7M	1.746, 5.895LX		66.54FT 2028.26CM
26.25FT 8M	1.337, 4.513LX		76.05FT 2318.02CM
29.52FT 9M	1.056, 3.566LX		85.56FT 2607.77CM
32.80FT 10M	0.8557, 2.889LX		95.06FT 2897.52CM
HT	EAVG/EMAX	ANGLE: 110.77DEG	DIA

LUMINOUS INTENSITY DISTRIBUTION DIAGRAM

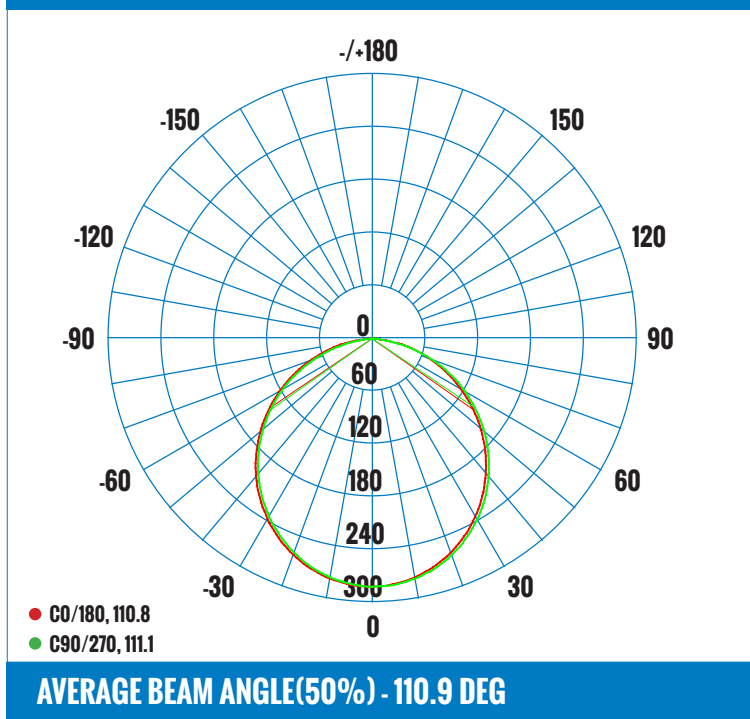

CERTIFICATIONS



DRIVER / LED CHIP



120V APPROVED DIMMERS

LUTRON: DVELV-300P · SELV-300P · SFTU-5A3P · DVCL-153P · CTCL-153P
 LEVITON: IPE05-1LZ · 6615
 WATTSTOPPER: HDCL-453M

ACCESSORIES



PRE-MOUNTING PLATE FOR NEW CONSTRUCTION APPLICATIONS AVAILABLE. PLEASE CONTACT ETLIN-DANIELS.



PART NO#: DLSW4-MP

ORDERING INFORMATION - DLSWR SERIES

SERIES	SHAPE	SIZE	WATTAGE	VOLTAGE	LOW VOLTAGE OUTPUT	COLOR TEMPERATURE	DIMMABLE	COLOR	LENS
E.G. DLSW	R	4	12	1	L	C	D	WH	FF
DLS - DOWNLIGHT SLIM	R - ROUND	4 - 4"	12 - 12W	1 - 120V	L - LOW VOLTAGE	C - CHANGEABLE	D - TRIAC	WH - WHITE	FF -
WET LOCATION					OUTPUT 24 - 36VDC	3000K, 4000K, 5000K	DIMMABLE		FROSTED

IF PRE-MOUNTING PLATE IS REQUIRED FOR NEW CONSTRUCTION PROJECTS, PLEASE QUOTE: PART NO#: DLSWR4-MP WHEN ORDERING.