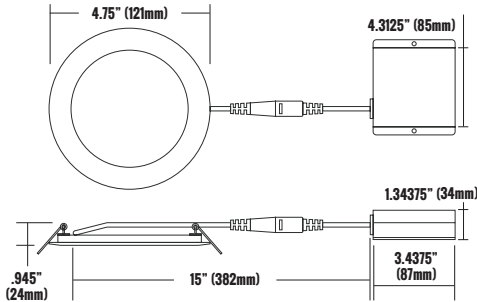

CATALOG #		TYPE
PROJECT		DATE
PREPARED BY		

**PRODUCT CODE: DLSWR4-914D-BN-FF**
**4 INCH LED ULTRA SLIM PROFILE DOWNLIGHT**
**B3**

**RECESSED LOW PROFILE**

## PRODUCT DESCRIPTION

The Etlin-Daniels DLSWR4-914D-BN-FF LED Ultraslim Profile Downlight is a modern, sleek looking energy efficient option for both new construction and retrofit/remodeling projects. It installs easily where there is limited ceiling space due to ductwork, joists and beams. With Etlin-Daniels IP65 rating, our Ultraslim Downlights are suitable for a wide range of both indoor & outdoor applications. Why waste time installing older space restrictive recessed options when the Etlin-Daniels Ultraslim Profile Downlight provides a quick install solution and elegant, superior quality lighting for both residential and commercial applications?

- Aluminum hardwire box with dimmable LED driver
- Includes a 7" cable from driver to fixture

## FEATURES

- LED light source
- 4" LED downlight
- Durable air tight Aluminum body
- Elegant Brushed Nickel finish
- Etched white Polycarbonate diffuser lens
- Includes two spring loaded clips for mounting to any ceiling material
- The slim profile design allows mounting under joists or duct work
- 50,000hrs L70 life
- Triac dimmable
- IC Air-tight rated
- Suitable for wet location - IP65
- 5 year limited warranty

## PRODUCT SPECIFICATIONS (OPTICAL DATA)

## PRODUCT SPECIFICATIONS (ELECTRICAL DATA)

LED TYPE	LED QTY	SYSTEM EFFICACY	LUMENS	COLOR TEMPERATURE	BEAM ANGLE	CRI	SYSTEM EFFICIENCY	VOLTAGE	POWER FREQ.	POWER EFFICIENCY	POWER FACTOR	HARMONIC DISTORTION
HONGLI TRONIC	45 CHIPS	61LM/W	550LM	4000K	120°	>80CRI	>90%	AC120V	50-60HZ	>80%	>0.98	<10%

## PRODUCT SPECIFICATIONS

WATTAGE	FIXTURE MATERIAL	LIFE SPAN	STORAGE TEMP	OPERATING TEMP	PRODUCT DIMENSIONS	CARTON SIZE
9W	ALUMINUM/ POLYCARBONATE LENS	>50,000 HOURS	-40°C~+100°C -40°F~+212°F	-40°C~+85°C -40°F~+185°F	4.75 X .945 X 4.75 INCHES (121 X 24 X 121 MM)	17.32 X 11.02 X 9.05 INCHES (440 X 280 X 230MM)

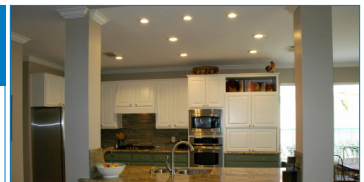

## ADDITIONAL INFORMATION

### INSTALLATION METHOD

**RECESSED CEILING MOUNT**

### FIXTURE COLOR

**BRUSHED NICKEL WITH WHITE  
ETCHED DIFFUSER**

### CONTROL TYPE

**TRIAC DIMMABLE DRIVER INCLUDED**

CATALOG #		TYPE
PROJECT		DATE
PREPARED BY		

**PRODUCT CODE: DLSWR4-914D-BN-FF 4 INCH LED ULTRA SLIM PROFILE DOWNLIGHT**

**LUMINAIRE PHOTOMETRIC (TEST REPORT)**



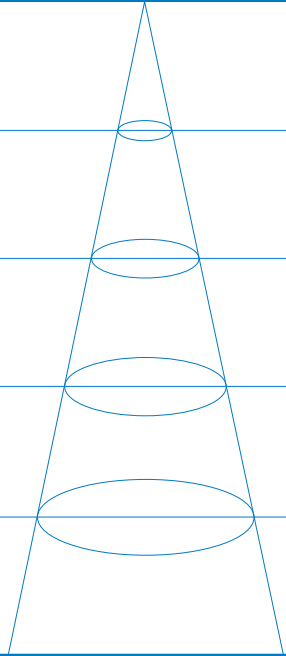

**ILLUMINANCE (AT A DISTANCE) FLUX OUT: 396.3LM**

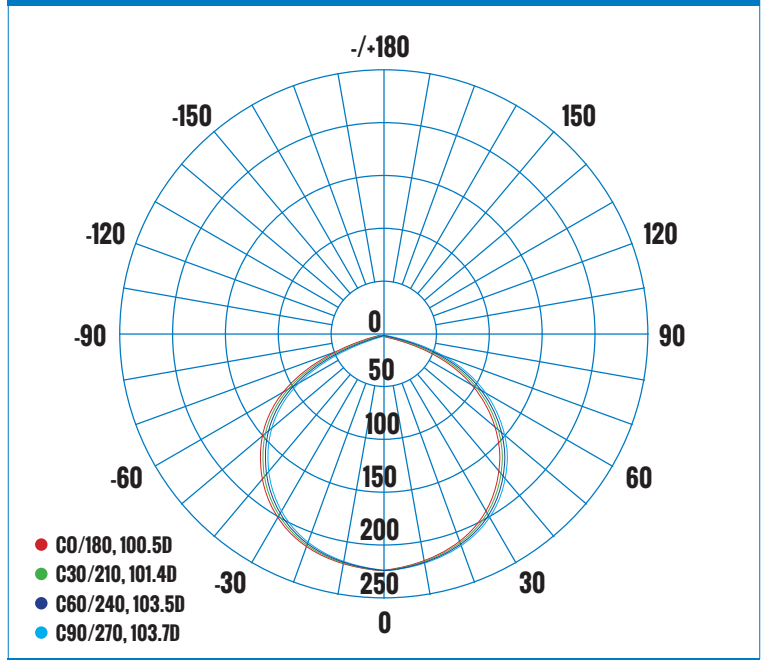
3.281FT 1M	7.963, 21.59FC 85.72, 232.4LX		7.9FT 240.78CM
6.562FT 2M	1.991, 5.397FC 21.43, 58.09LX		15.8FT 481.56CM
9.843FT 3M	0.8848, 2.399FC 9.524, 25.82LX		23.7FT 722.34CM
13.12FT 4M	0.4977, 1.349FC 5.357, 14.52LX		31.6FT 963.11CM
16.4FT 5M	0.3185, 0.863FC 3.429, 9.294LX		39.5FT 1203.89CM
<b>HT</b>	<b>EAVG/EMAX</b>	<b>ANGLE: 100.57DEG</b>	<b>DIA</b>

**LUMINOUS INTENSITY DISTRIBUTION DIAGRAM**



**AVERAGE BEAM ANGLE(50%) 116.1DEG**

<b>CERTIFICATIONS</b> 	<b>DRIVER / LED CHIP</b> 	<b>120V APPROVED DIMMERS</b> LUTRON: CTCL-153PDH · CTCL-153P · CT-600P LEVITON: 6672 · 6674 COOPER: HCL453PTCCCV6	<b>ACCESSORIES</b>  72" EXTENSION CORD PART# DLSEC-72 120" EXTENSION CORD PART# DLSEC-120	PRE-MOUNTING PLATE FOR NEW CONSTRUCTION APPLICATIONS AVAILABLE. PLEASE CONTACT ETLIN-DANIELS.  <b>PART NO#: DLSW4-MP</b>
---	---	---	--	---

**ORDERING INFORMATION - DLSW SERIES**

SERIES	IP RATING	SHAPE	SIZE	WATTAGE	VOLTAGE	COLOR TEMPERATURE	DIMMABLE	COLOR	LENS	TRIM
E.G. DLS	W	R	4	9	1	4	D	BN	F	F
DLS - DOWNLIGHT SLIM	W - WET LOCATION IP65	R - ROUND	4 - 4"	9 - 9W	1 - 120V	4 - 4000K	D - TRIAC	BN - BRUSHED NICKEL	F - FROSTED	F - FIXED

**IF PRE-MOUNTING PLATE IS REQUIRED FOR NEW CONSTRUCTION PROJECTS, PLEASE QUOTE: PART NO#: DLS4-MP WHEN ORDERING.**

Head Office - 1850 Wilson Ave. · Toronto, ON · M9M 1A1 · Tel: 416.741.7336 · Fax: 416.741.9104

Toll Free: in Canada. 1.800.661.9610 · in USA. 1.888.762.5384 (SOCKETS4U)

www.etlin-daniels.com · For sales/service questions · sales@etlin.com