

PRODUCT CODE: DLSWR6-121L5C9D-WH-FF

6 INCH LED ULTRATHIN DOWNLIGHT - 5CCT SERIES

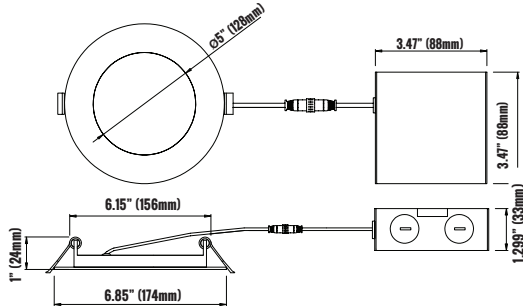

## PRODUCT DESCRIPTION

Etlin-Daniels introduces our latest LED Recessed Ultrathin Downlights - the 121L5C9D series. This new generation is available with a 5CCT switch - providing for a choice between 2700K, 3000K, 3500K, 4000K & 5000K. This feature will reduce inventory stress and facilitate any potential color temperature decisions when doing the installations.

The new DLSWR6-121L5C9D-WH-FF 6" fixture offers a modern and sleek looking energy efficient option for both new construction and retrofit / remodelling projects. It installs easily where there is limited ceiling space due to ductwork, joists and beams.

The new 121L5C9D design comes with a white trim - snap-on black and brushed nickel trims are available as options. Why waste time installing older space restrictive recessed options when the new Etlin-Daniels wet location rated, 5CCT Ultrathin provides a quick install solution, and elegant, superior illumination for your residential or commercial projects? Triac dimmable.

## FEATURES

- LED Indoor Light Source
- 6" LED Downlight
- Durable air-tight aluminum body
- IC Air-Tight rated
- Wet location rated (indoor)
- Elegant white paint finish
- Etched white Polycarbonate diffuser lens for glare free illumination
- 2 spring loaded clips for mounting to any ceiling material
- 5CCT switch conveniently located allows choice of 2700K, 3000K, 3500K, 4000K, 5000K
- Default CT setting is 3000K
- Snap-on trims available in black & brushed nickel
- Triac dimmable
- 5 year warranty
- Energy Star certified

## PRODUCT SPECIFICATIONS (OPTICAL DATA)

## PRODUCT SPECIFICATIONS (ELECTRICAL DATA)

LED TYPE	LED QTY	WATTAGE	COLOR TEMPERATURE	LUMENS	VOLTAGES	SYSTEM EFFICACY	CRI	SYSTEM EFFICIENCY	POWER EFFICIENCY	POWER FACTOR	HARMONIC DISTORTION
HONGLI 2835	48 CHIPS	12W - 2700K - 811 LM / 3000K - 877 LM / 3500K - 910 LM / 4000K - 917 LM / 5000K - 888 LM			INPUT - 120VAC OUTPUT - 24 - 36VDC	67.5 LM/W 73.08 LM/W 75.83 LM/W 76.42 LM/W 74 LM/W	>90 CRI	>0.96%	>80%	>0.90	<40%

## PRODUCT SPECIFICATIONS

BEAM ANGLE	POWER FREQ.	FIXTURE MATERIAL	LIFE SPAN	STORAGE TEMP	OPERATING TEMP	PRODUCT DIMENSIONS	CARTON SIZE
120°	50-60HZ	ALUMINUM/ POLYCARBONATE LENS	>50,000 HOURS	-40°C~+60°C -40°F~+140°F	-30°C~+40°C -40°F~+104°F	06.85 X 1 INCHES (174 X 24 MM)	7.48 X 7.48 X 2.46 INCHES (180 X 180 X 55MM)

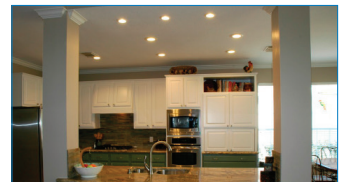

## ADDITIONAL INFORMATION

### INSTALLATION METHOD

RECESSED CEILING MOUNT

### FIXTURE COLOR

WHITE WITH WHITE ETCHED DIFFUSER

### CONTROL TYPE

TRIAC DIMMABLE DRIVER INCLUDED

**PRODUCT CODE: DLSWR6-121L5C9D-WH-FF**
**6 INCH LED ULTRATHIN DOWNLIGHT - 5CCT SERIES**
**LUMINAIRE PHOTOMETRIC (TEST REPORT) - 2700K**
**ILLUMINANCE (AT A DISTANCE) - FLUX OUT: 592.7 LM**

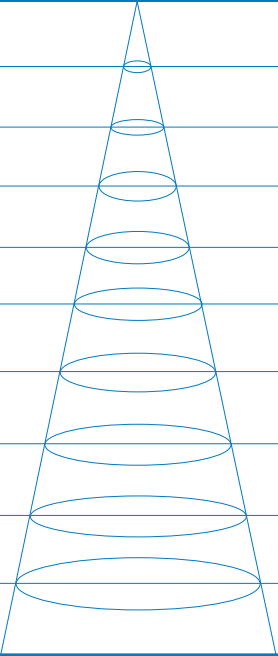
3.28FT 1M	85.83, 291.0LX		286.85CM
6.56FT 2M	21.46, 72.74LX		573.70CM
9.84FT 3M	9.537, 32.33LX		860.55CM
13.12FT 4M	5.364, 18.18LX		1147.41CM
16.40FT 5M	3.433, 11.64LX		1434.26CM
19.69FT 6M	2.384, 8.082LX		1721.11CM
22.97FT 7M	1.752, 5.938LX		2007.96CM
26.25FT 8M	1.341, 4.546LX		2294.81CM
29.52FT 9M	1.060, 3.592LX		2581.67CM
32.80FT 10M	0.8583, 2.910LX		2868.52CM
<b>HT</b>	<b>EAVG/EMAX</b>	<b>ANGLE: 110.23DEG</b>	<b>DIA</b>

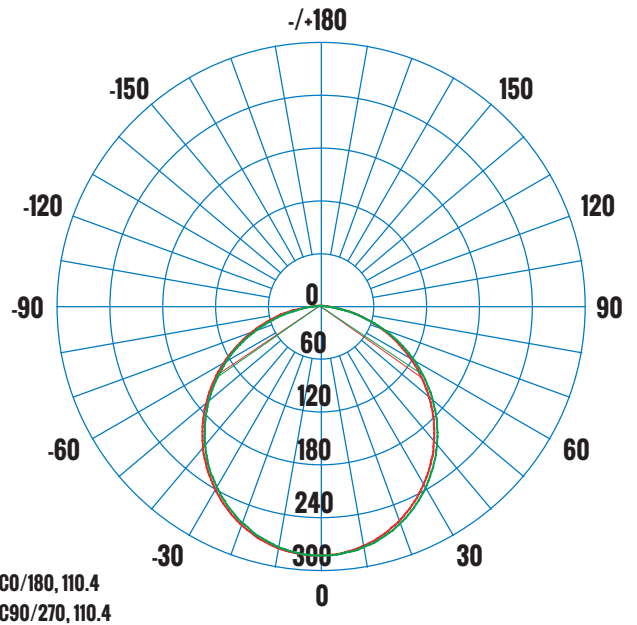
**LUMINOUS INTENSITY DISTRIBUTION DIAGRAM**

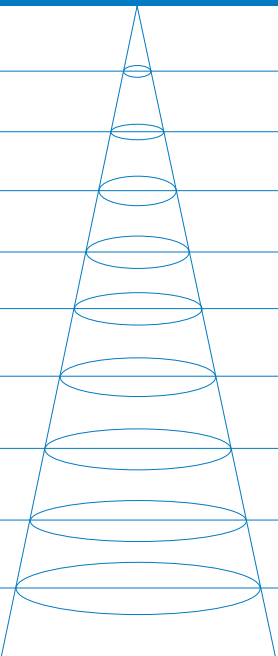
**AVERAGE BEAM ANGLE(50%) - 110.4 DEG**
**LUMINAIRE PHOTOMETRIC (TEST REPORT) - 3000K**
**ILLUMINANCE (AT A DISTANCE) - FLUX OUT: 640.9 LM**

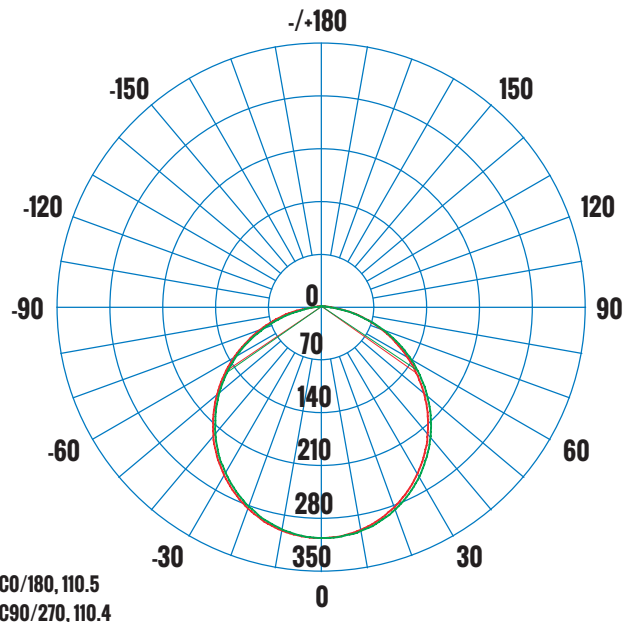
3.28FT 1M	92.82, 314.0LX		287.60CM
6.56FT 2M	23.21, 78.51LX		575.20CM
9.84FT 3M	10.31, 34.89LX		862.80CM
13.12FT 4M	5.801, 19.63LX		1150.40CM
16.40FT 5M	3.713, 12.56LX		1438.00CM
19.69FT 6M	2.578, 8.723LX		1725.60CM
22.97FT 7M	1.894, 6.409LX		2013.20CM
26.25FT 8M	1.450, 4.907LX		2300.80CM
29.52FT 9M	1.146, 3.877LX		2588.40CM
32.80FT 10M	0.9282, 3.140LX		2876.00CM
<b>HT</b>	<b>EAVG/EMAX</b>	<b>ANGLE: 110.37DEG</b>	<b>DIA</b>

**LUMINOUS INTENSITY DISTRIBUTION DIAGRAM**

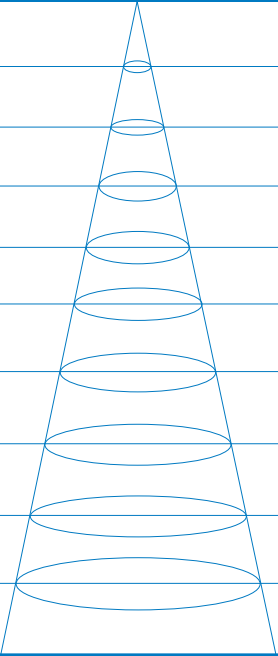
**AVERAGE BEAM ANGLE(50%) - 110.5 DEG**

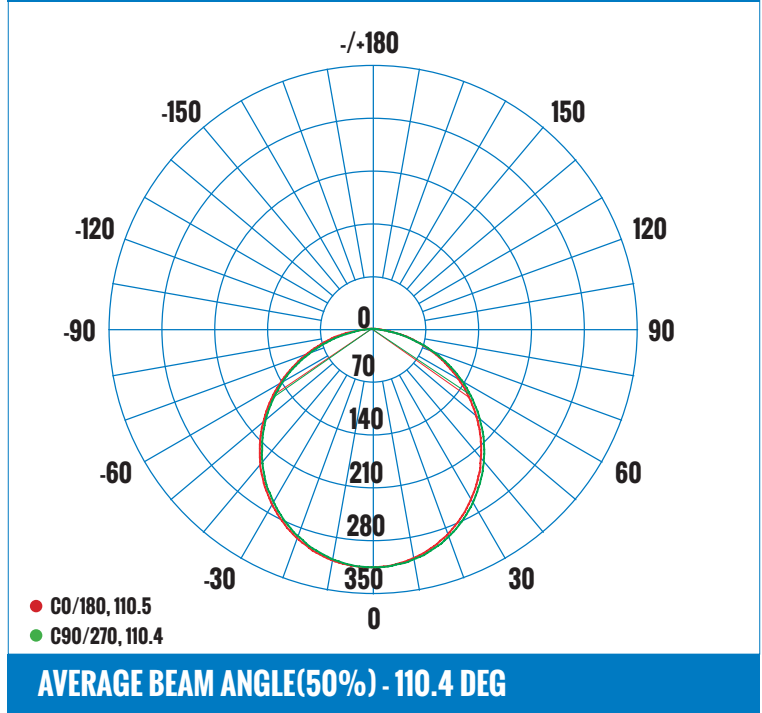
**PRODUCT CODE: DLSWR6-121L5C9D-WH-FF**
**6 INCH LED ULTRATHIN DOWNLIGHT - 5CCT SERIES**
**LUMINAIRE PHOTOMETRIC (TEST REPORT) - 3500K**
**ILLUMINANCE (AT A DISTANCE) - FLUX OUT: 665.4 LM**

3.28FT 1M	96.36, 326.0LX		287.55CM
6.56FT 2M	24.09, 81.50LX		575.09CM
9.84FT 3M	10.71, 36.22LX		862.64CM
13.12FT 4M	6.022, 20.37LX		1150.19CM
16.40FT 5M	3.854, 13.04LX		1437.73CM
19.69FT 6M	2.677, 9.055LX		1725.27CM
22.97FT 7M	1.966, 6.653LX		2012.83CM
26.25FT 8M	1.506, 5.094LX		2300.37CM
29.52FT 9M	1.190, 4.025LX		2587.92CM
32.80FT 10M	0.9636, 3.260LX		2875.46CM
<b>HT</b>	<b>EAVG/EMAX</b>	<b>ANGLE: 110.36DEG</b>	<b>DIA</b>

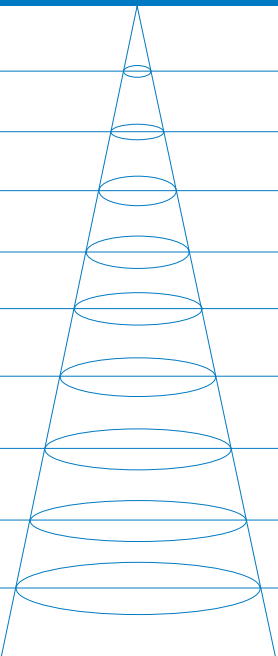
**LUMINOUS INTENSITY DISTRIBUTION DIAGRAM**

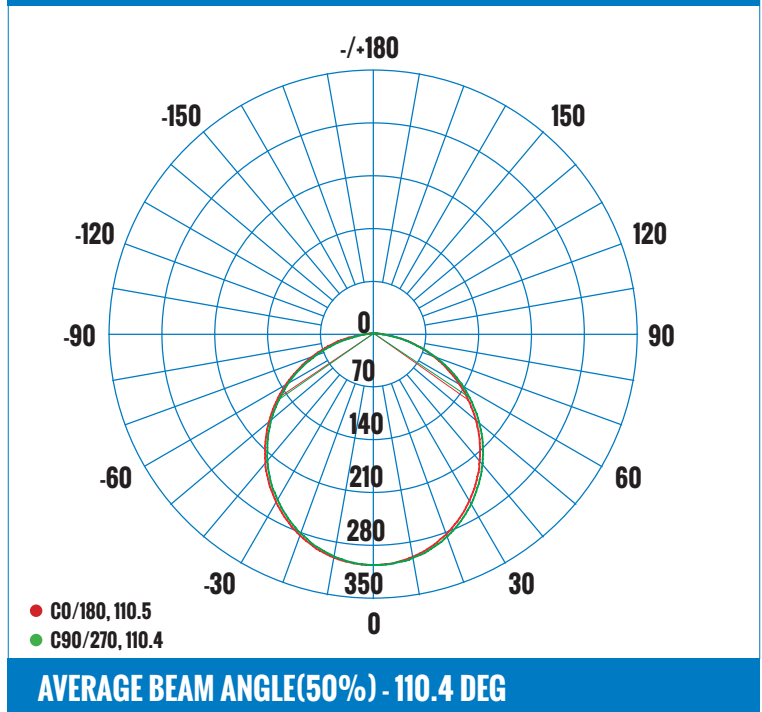
**LUMINAIRE PHOTOMETRIC (TEST REPORT) - 4000K**
**ILLUMINANCE (AT A DISTANCE) - FLUX OUT: 670.3 LM**

3.28FT 1M	97.08, 328.4LX		287.49CM
6.56FT 2M	24.27, 82.10LX		574.99CM
9.84FT 3M	10.79, 36.49LX		862.48CM
13.12FT 4M	6.067, 20.53LX		1149.97CM
16.40FT 5M	3.883, 13.14LX		1437.46CM
19.69FT 6M	2.697, 9.123LX		1724.95CM
22.97FT 7M	1.981, 6.702LX		2012.45CM
26.25FT 8M	1.517, 5.131LX		2299.94CM
29.52FT 9M	1.198, 4.054LX		2587.44CM
32.80FT 10M	0.9708, 3.284LX		2874.93CM
<b>HT</b>	<b>EAVG/EMAX</b>	<b>ANGLE: 110.35DEG</b>	<b>DIA</b>

**LUMINOUS INTENSITY DISTRIBUTION DIAGRAM**

CATALOG #		TYPE
PROJECT		DATE
PREPARED BY		

**PRODUCT CODE: DLSWR6-121L5C9D-WH-FF**

**6 INCH LED ULTRATHIN DOWNLIGHT - 5CCT SERIES**

**LUMINAIRE PHOTOMETRIC (TEST REPORT) - 5000K**

**ILLUMINANCE (AT A DISTANCE) - FLUX OUT: 648.7 LM**

3.28FT 1M	93.95, 317.8LX		287.49CM
6.56FT 2M	23.49, 79.44LX		574.99CM
9.84FT 3M	10.44, 35.31LX		862.48CM
13.12FT 4M	5.872, 19.86LX		1149.97CM
16.40FT 5M	3.758, 12.71LX		1437.46CM
19.69FT 6M	2.610, 8.817LX		1724.95CM
22.97FT 7M	1.917, 6.485LX		2012.45CM
26.25FT 8M	1.468, 4.965LX		2299.94CM
29.52FT 9M	1.160, 3.923LX		2587.44CM
32.80FT 10M	0.9395, 3.178LX		2874.93CM
<b>HT</b>	<b>EAVG/EMAX</b>	<b>ANGLE: 110.35DEG</b>	<b>DIA</b>

**LUMINOUS INTENSITY DISTRIBUTION DIAGRAM**

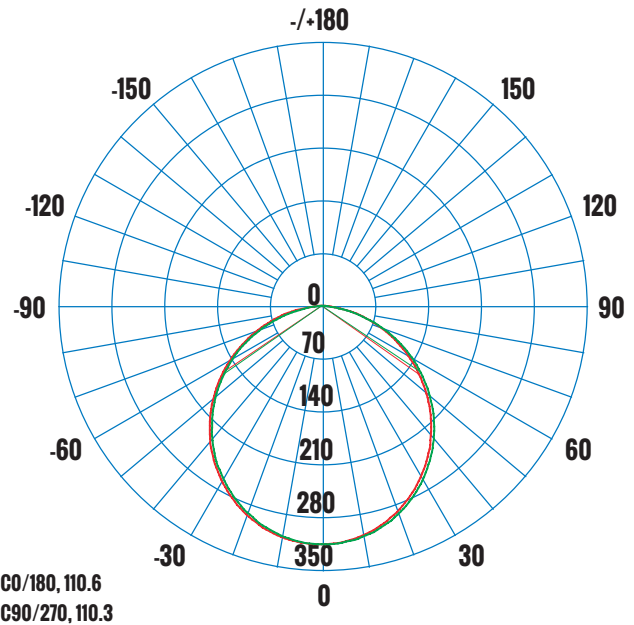

**AVERAGE BEAM ANGLE(50%) - 110.5 DEG**

<b>CERTIFICATIONS</b> 	<b>DRIVER / LED CHIP</b> 	<b>120V APPROVED DIMMERS</b> LUTRON: DVELV-300P · SELV-300P · SFTU-5A3P · DVCL-153P · CTCL-153P LEVITON: IPE05-1LZ · 6615 WATTSTOPPER: HDCL-453M	<b>ACCESSORIES</b> <p>CLIP-ON TRIM BLACK PART# DLSTM6-BL                  CLIP-ON TRIM BRUSHED NICKEL PART# DLSTM6-BN</p> <p>72" EXTENSION CORD PART# DLSEC-72-FT4-3P                  120" EXTENSION CORD PART# DLSEC-120-FT4-3P                  240" EXTENSION CORD PART# DLSEC-240-FT4-3P</p>	PRE-MOUNTING PLATE FOR NEW CONSTRUCTION APPLICATIONS AVAILABLE. PLEASE CONTACT ETLIN-DANIELS. <p><b>PART NO#: DLSW6-MP</b></p>
---------------------------	------------------------------	---	--	---

**ORDERING INFORMATION - DLSWR SERIES**

SERIES	SHAPE	SIZE	WATTAGE	VOLTAGE	LOW VOLTAGE OUTPUT	COLOR TEMPERATURE	CRI / DIMMABLE	COLOR	LENS
E.G. DLSW	R	6	12	1	L	5C	9D	WH	FF
DLS - DOWNLIGHT SLIM	R - ROUND	6 - 6"	12 - 12W	1 - 120V	L - LOW VOLTAGE	5C - 5CCT	C - 90 CRI	WH - WHITE	FF -
WET LOCATION					OUTPUT 24 - 36VDC	2700K, 3000K, 3500K, 4000K, 5000K	D - TRIAC DIMMABLE		FROSTED

**IF PRE-MOUNTING PLATE IS REQUIRED FOR NEW CONSTRUCTION PROJECTS, PLEASE QUOTE: PART NO#: DLSWR6-MP WHEN ORDERING.**

Head Office - 1850 Wilson Ave. · Toronto, ON · M9M 1A1 · Tel: 416.741.7336 · Fax: 416.741.9104

Toll Free: in Canada. 1.800.661.9610 · in USA. 1.888.762.5384 (SOCKETS4U)

www.etlin-daniels.com · For sales/service questions - sales@etlin.com