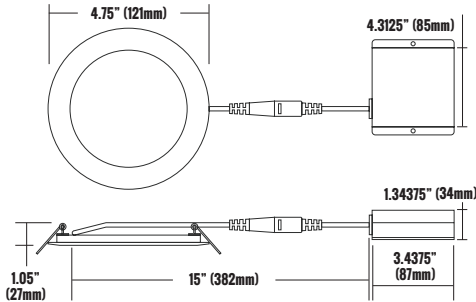

CATALOG #		TYPE
PROJECT		DATE
PREPARED BY		

PRODUCT CODE: DLSWRH4-1214D-BN-FF
4 INCH LED ULTRA SLIM PROFILE DOWNLIGHT /HEAT SINK
B11

RECESSED LOW PROFILE

PRODUCT DESCRIPTION

The Etlin-Daniels DLSWRH4-1214D-BN-FF LED Ultraslim Profile Downlight is a modern, sleek looking energy efficient option for both new construction and retrofit/remodeling projects. It installs easily where there is limited ceiling space due to ductwork, joists and beams. With Etlin-Daniels IP65 rating, our Ultraslim Downlights are suitable for a wide range of both indoor & outdoor applications. Why waste time installing older space restrictive recessed options when the Etlin-Daniels Ultraslim Profile Downlight provides a quick install solution and elegant, superior quality lighting for both residential and commercial applications?

- Aluminum hardwire box with dimmable LED driver
- Includes a 7" cable from driver to fixture
- Built in Heat Sink

FEATURES

- LED light source
- 4" LED downlight
- Durable air tight Aluminum body
- Elegant Brushed Nickel finish
- Etched white Polycarbonate diffuser lens
- Includes two spring loaded clips for mounting to any ceiling material
- The slim profile design allows mounting under joists or duct work
- 50,000hrs L70 life
- Triac dimmable
- IC Air-tight rated
- Suitable for wet location - IP65
- 5 year limited warranty

PRODUCT SPECIFICATIONS (OPTICAL DATA)

PRODUCT SPECIFICATIONS (ELECTRICAL DATA)

LED TYPE	LED QTY	SYSTEM EFFICACY	LUMENS	COLOR TEMPERATURE	BEAM ANGLE	CRI	SYSTEM EFFICIENCY	VOLTAGE	POWER FREQ.	POWER EFFICIENCY	POWER FACTOR	HARMONIC DISTORTION
HONGLI TRONIC	27 CHIPS	58.3LM/W	700LM	4000K	120°	>80CRI	>90%	AC120V	50-60HZ	>80%	>0.98	<10%

PRODUCT SPECIFICATIONS

WATTAGE	FIXTURE MATERIAL	LIFE SPAN	STORAGE TEMP	OPERATING TEMP	PRODUCT DIMENSIONS	CARTON SIZE
12W	ALUMINUM/ POLYCARBONATE LENS	>50,000 HOURS	- 40°C~+100°C - 40°F~+212°F	- 40°C~+85°C - 40°F~+185°F	4.75 X 1.05 X 4.75 INCHES (121 X 27 X 121 MM)	17.32 X 11.02 X 9.05 INCHES (440 X 280 X 230MM)



ADDITIONAL INFORMATION

INSTALLATION METHOD

RECESSED CEILING MOUNT

FIXTURE COLOR

**BRUSHED NICKEL WITH WHITE
ETCHED DIFFUSER**

CONTROL TYPE

TRIAC DIMMABLE DRIVER INCLUDED

CATALOG #		TYPE
PROJECT		DATE
PREPARED BY		

PRODUCT CODE: DLSWRH4-1214D-BN-FF 4 INCH LED ULTRA SLIM PROFILE DOWNLIGHT/HEAT SINK



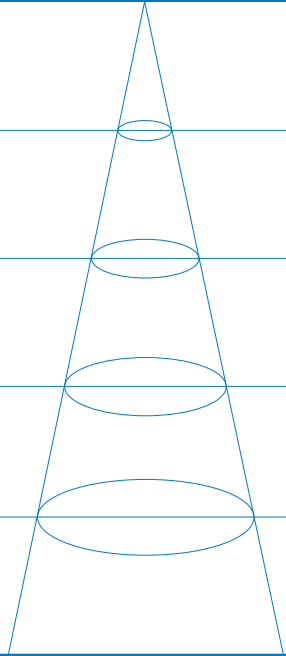

LUMINAIRE PHOTOMETRIC (TEST REPORT)

ILLUMINANCE (AT A DISTANCE) FLUX OUT: 605.1LM

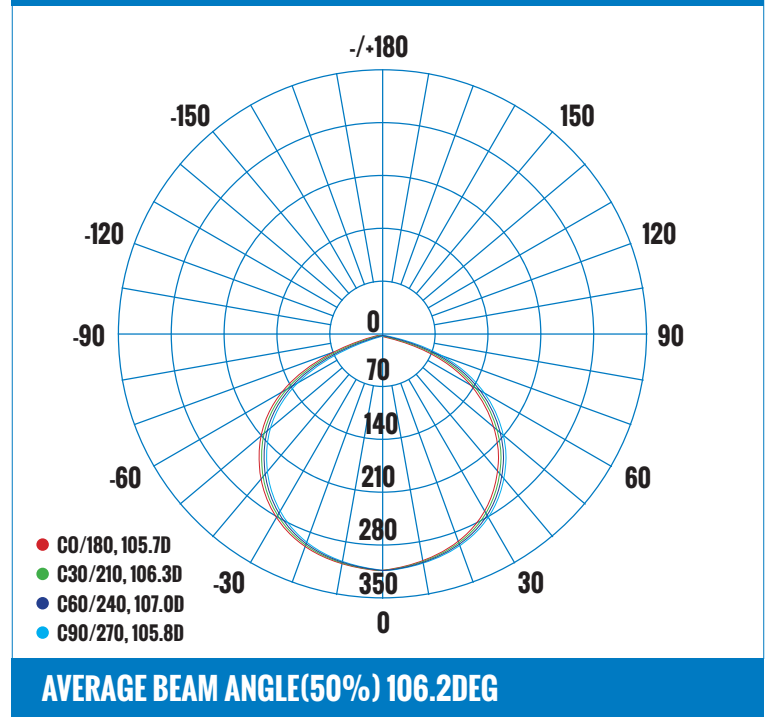
3.281FT 1M	10.16, 30.25FC 109.4, 325.7LX		8.656FT 263.83CM
6.562FT 2M	2.540, 7.564FC 27.34, 81.41LX		17.31FT 527.65CM
9.843FT 3M	1.129, 3.362FC 12.15, 36.18LX		25.97FT 791.48CM
13.12FT 4M	0.6350, 1.891FC 6.835, 20.35LX		34.62FT 1055.31CM
16.4FT 5M	0.4064, 1.210FC 4.375, 13.03LX		43.28FT 1319.13CM
HT	EAVG/EMAX	ANGLE: 105.67DEG	DIA

LUMINOUS INTENSITY DISTRIBUTION DIAGRAM



CERTIFICATIONS 	DRIVER / LED CHIP 	120V APPROVED DIMMERS LUTRON: CTCL-153PDH · CTCL-153P · CT-600P LEVITON: 6672 · 6674 COOPER: HCL453PTCCCV6	ACCESSORIES  <p>72" EXTENSION CORD PART# DLSEC-72</p> <p>120" EXTENSION CORD PART# DLSEC-120</p>	PRE-MOUNTING PLATE FOR NEW CONSTRUCTION APPLICATIONS AVAILABLE. PLEASE CONTACT ETLIN-DANIELS.  PART NO#: DLS4-MP
---	---	---	--	--

ORDERING INFORMATION - DLSW SERIES

SERIES	IP RATING	SHAPE	HEAT DISSIPATION	SIZE	WATTAGE	VOLTAGE	COLOR TEMPERATURE	DIMMABLE	COLOR	LENS	TRIM
E.G. DLS	W	R	H	4	12	1	4	D	BN	F	F
DLS - DOWNLIGHT SLIM	W - WET LOCATION IP65	R - ROUND	H - HEAT SINK	4 - 4"	12 - 12W	1 - 120V	4 - 4000K	D - TRIAC	BN - BRUSHED NICKEL	F - FROSTED	F - FIXED

Head Office - 1850 Wilson Ave. · Toronto, ON · M9M 1A1 · Tel: 416.741.7336 · Fax: 416.741.9104

Toll Free: in Canada. 1.800.661.9610 · in USA. 1.888.762.5384 (SOCKETS4U)

www.etlin-daniels.com · For sales/service questions · sales@etlin.com