

CATALOG #		TYPE
PROJECT		DATE
PREPARED BY		

PRODUCT CODE: DLSWRH6-1513D-BN-FF 6 INCH LED ULTRA SLIM PROFILE DOWNLIGHT /HEAT SINK

B13

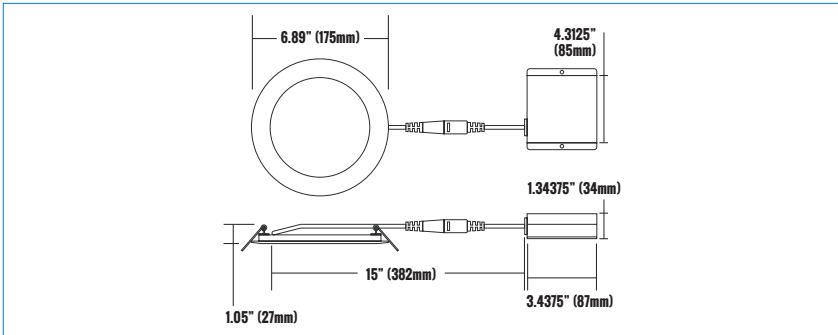

RECESSED LOW PROFILE

PRODUCT DESCRIPTION

The Etlin-Daniels DLSWRH6-1513D-BN-FF LED Ultraslim Profile Downlight is a modern, sleek looking energy efficient option for both new construction and retrofit/remodeling projects. It installs easily where there is limited ceiling space due to ductwork, joists and beams. With Etlin-Daniels IP65 rating, our Ultraslim Downlights are suitable for a wide range of both indoor & outdoor applications. Why waste time installing older space restrictive recessed options when the Etlin-Daniels Ultraslim Profile Downlight provides a quick install solution and elegant, superior quality lighting for both residential and commercial applications?

- Aluminum hardwire box with dimmable LED driver
- Includes a 7" cable from driver to fixture
- Built in Heat Sink

FEATURES

- LED light source
- 4" LED downlight
- Durable air tight Aluminum body
- Elegant Brushed Nickel finish
- Etched white Polycarbonate diffuser lens
- Includes two spring loaded clips for mounting to any ceiling material
- The slim profile design allows mounting under joists or duct work
- 50,000hrs L70 life
- Triac dimmable
- IC Air-tight rated
- Suitable for wet location - IP65
- 5 year limited warranty

PRODUCT SPECIFICATIONS (OPTICAL DATA)								PRODUCT SPECIFICATIONS (ELECTRICAL DATA)				
LED TYPE	LED QTY	SYSTEM EFFICACY	LUMENS	COLOR TEMPERATURE	BEAM ANGLE	CRI	SYSTEM EFFICIENCY	VOLTAGE	POWER FREQ.	POWER EFFICIENCY	POWER FACTOR	HARMONIC DISTORTION
HONGLI TRONIC	36 CHIPS	60LM/W	900LM	3000K	120°	>80CRI	>90%	AC120V	50-60HZ	>80%	>0.98	<10%

PRODUCT SPECIFICATIONS

WATTAGE	FIXTURE MATERIAL	LIFE SPAN	STORAGE TEMP	OPERATING TEMP	PRODUCT DIMENSIONS	CARTON SIZE	
15W	ALUMINUM/ POLYCARBONATE LENS	>50,000 HOURS	- 40°C~+100°C - 40°F~+212°F	- 40°C~+85°C - 40°F~+185°F	6.89 X 1.05 X 6.89 INCHES (175 X 27 X 175 MM)	17.32 X 11.02 X 9.05 INCHES (440 X 280 X 230MM)	

ADDITIONAL INFORMATION	INSTALLATION METHOD	FIXTURE COLOR	CONTROL TYPE
	RECESSED CEILING MOUNT	BRUSHED NICKEL WITH WHITE ETCHED DIFFUSER	TRIAC DIMMABLE DRIVER INCLUDED

CATALOG #		TYPE
PROJECT		DATE
PREPARED BY		

PRODUCT CODE: DLSWRH6-1513D-BN-FF

6 INCH LED ULTRA SLIM PROFILE DOWNLIGHT/HEAT SINK



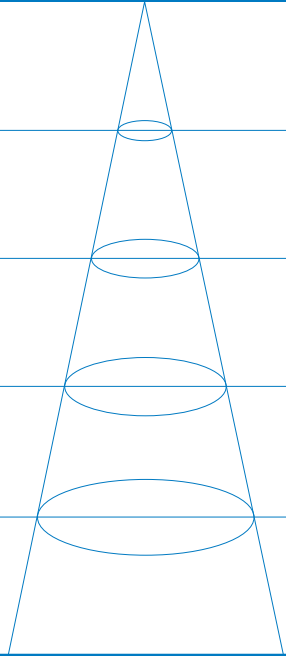

LUMINAIRE PHOTOMETRIC (TEST REPORT)

ILLUMINANCE (AT A DISTANCE) FLUX OUT: 817.8LM

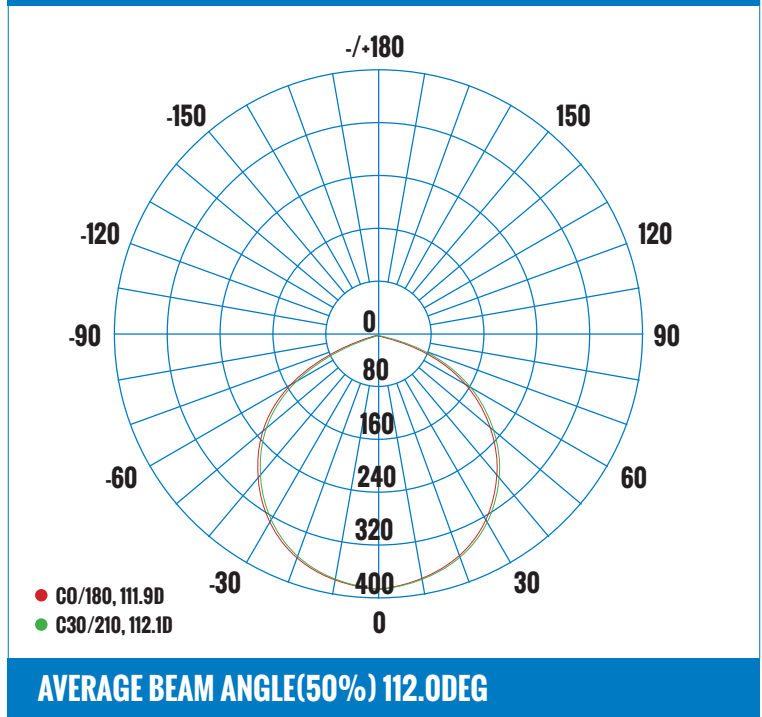
3.281FT 1M	11.00, 36.84FC 118.4, 396.51LX		9.709FT 295.92CM
6.562FT 2M	2.751, 9.209FC 29.61, 99.13LX		19.42FT 591.84CM
9.843FT 3M	1.222, 4.093FC 13.16, 44.06LX		29.13FT 887.76CM
13.12FT 4M	0.6877, 2.302FC 7.402, 24.78LX		38.83FT 1183.68CM
16.4FT 5M	0.4401, 1.472FC 4.737, 15.86LX		48.54FT 1479.60CM
HT	EAVG/EMAX	ANGLE: 111.89DEG	DIA

LUMINOUS INTENSITY DISTRIBUTION DIAGRAM



CERTIFICATIONS 	DRIVER / LED CHIP 	120V APPROVED DIMMERS LUTRON: CTCL-153PDH · CTCL-153P · CT-600P LEVITON: 6672 · 6674 COOPER: HCL453PTCCCV6	ACCESSORIES  <p>72" EXTENSION CORD PART# DLSEC-72</p> <p>120" EXTENSION CORD PART# DLSEC-120</p>	PRE-MOUNTING PLATE FOR NEW CONSTRUCTION APPLICATIONS AVAILABLE. PLEASE CONTACT ETLIN-DANIELS.  <p>PART NO#: DLS6-MP</p>
---	---	---	--	--

ORDERING INFORMATION - DLSW SERIES

SERIES	IP RATING	SHAPE	HEAT DISSIPATION	SIZE	WATTAGE	VOLTAGE	COLOR TEMPERATURE	DIMMABLE	COLOR	LENS	TRIM
E.G. DLS	W	R	H	6	15	1	3	D	BN	F	F
DLS - DOWNLIGHT SLIM	W - WET LOCATION IP65	R - ROUND	H - HEAT SINK	6 - 6"	15 - 15W	1 - 120V	3 - 3000K	D - TRIAC	BN - BRUSHED NICKEL	F - FROSTED	F - FIXED

Head Office - 1850 Wilson Ave. · Toronto, ON · M9M 1A1 · Tel: 416.741.7336 · Fax: 416.741.9104

Toll Free: in Canada. 1.800.661.9610 · in USA. 1.888.762.5384 (SOCKETS4U)

www.etlin-daniels.com · For sales/service questions · sales@etlin.com