

CATALOG #		TYPE
PROJECT		DATE
PREPARED BY		

PRODUCT CODE: DLSWS6-1213D-BN-FF

6 INCH LED ULTRA SLIM PROFILE DOWNLIGHT /SQUARE

B21

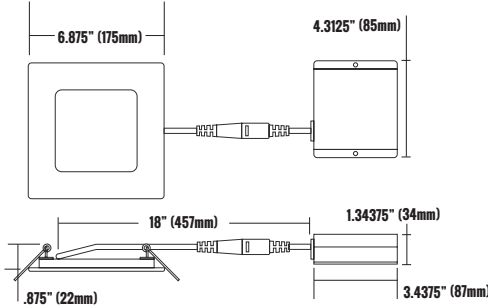

RECESSED LOW PROFILE

PRODUCT DESCRIPTION

The Etlin-Daniels DLSWS6-1213D-BN-FF LED Ultraslim Profile Square Downlight is a modern, sleek looking energy efficient option for both new construction and retrofit/remodeling projects. It installs easily where there is limited ceiling space due to ductwork, joists and beams. With Etlin-Daniels IP65 rating, our Ultraslim Downlights are suitable for a wide range of both indoor & outdoor applications. Why waste time installing older space restrictive recessed options when the Etlin-Daniels Ultraslim Profile Downlight provides a quick install solution and elegant, superior quality lighting for both residential and commercial applications?

- Aluminum hardwire box with dimmable LED driver
- Includes a 7" cable from driver to fixture

FEATURES

- LED light source
- 6" LED downlight
- Durable air tight Aluminum body
- Elegant Brushed Nickel finish
- Etched white Polycarbonate diffuser lens
- Includes two spring loaded clips for mounting to any ceiling material
- The slim profile design allows mounting under joists or duct work
- 50,000hrs L70 life
- Triac dimmable
- IC Air-tight rated
- Suitable for wet location - IP65
- 5 year limited warranty

PRODUCT SPECIFICATIONS (OPTICAL DATA)

PRODUCT SPECIFICATIONS (ELECTRICAL DATA)

LED TYPE	LED QTY	SYSTEM EFFICACY	LUMENS	COLOR TEMPERATURE	BEAM ANGLE	CRI	SYSTEM EFFICIENCY	VOLTAGE	POWER FREQ.	POWER EFFICIENCY	POWER FACTOR	HARMONIC DISTORTION
HONGLI TRONIC	60 CHIPS	58.3LM/W	700LM	3000K	120°	>80CRI	>90%	AC120V	50-60HZ	>80%	>0.98	<10%

PRODUCT SPECIFICATIONS

WATTAGE	FIXTURE MATERIAL	LIFE SPAN	STORAGE TEMP	OPERATING TEMP	PRODUCT DIMENSIONS	CARTON SIZE
12W	ALUMINUM/ POLYCARBONATE LENS	>50,000 HOURS	- 40°C--100°C - 40°F--212°F	- 40°C--85°C - 40°F--185°F	6.875 X .875 X 6.875 INCHES (175 X 22 X 175 MM)	23.03 X 14.76 X 9.05 INCHES (585 X 375 X 230MM)

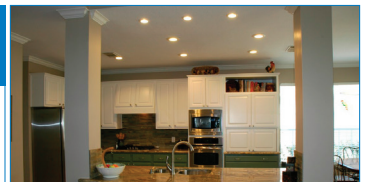

ADDITIONAL INFORMATION

INSTALLATION METHOD

RECESSED CEILING MOUNT

FIXTURE COLOR

BRUSHED NICKEL WITH WHITE
ETCHED DIFFUSER

CONTROL TYPE

TRIAC DIMMABLE DRIVER INCLUDED

CATALOG #		TYPE
PROJECT		DATE
PREPARED BY		

PRODUCT CODE: DLSWS6-1213D-BN-FF

6 INCH LED ULTRA SLIM PROFILE DOWNLIGHT/SQUARE



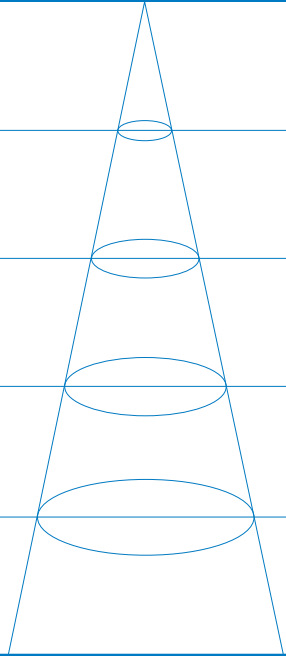

LUMINAIRE PHOTOMETRIC (TEST REPORT)

ILLUMINANCE (AT A DISTANCE) FLUX OUT: 671.1LM

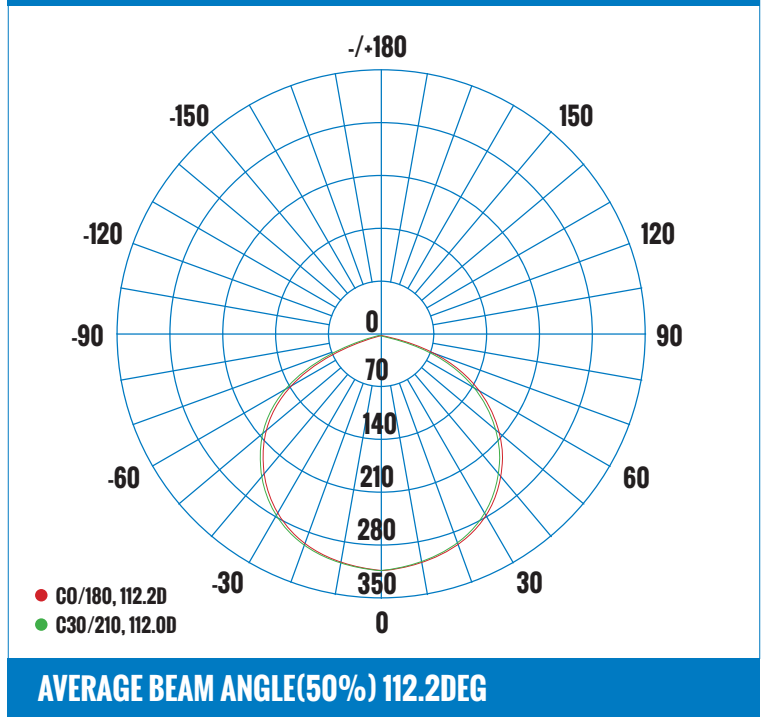
3.281FT 1M	9.030, 30.15FC 97.19, 324.61LX		9.692FT 295.42CM
6.562FT 2M	2.257, 7.538FC 24.30, 81.14LX		19.38FT 590.84CM
9.843FT 3M	1.003, 3.350FC 10.80, 36.06LX		29.08FT 886.26CM
13.12FT 4M	0.5644, 1.884FC 6.075, 20.28LX		38.77FT 1181.68CM
16.4FT 5M	0.3612, 1.206FC 3.888, 12.984LX		48.46FT 1477.10CM
HT	EAVG/EMAX	ANGLE: 111.80DEG	DIA

LUMINOUS INTENSITY DISTRIBUTION DIAGRAM



CERTIFICATIONS 	DRIVER / LED CHIP 	120V APPROVED DIMMERS LUTRON: CTCL-153PDH · CTCL-153P · CT-600P LEVITON: 6672 · 6674 COOPER: HCL453PTCCCV6	ACCESSORIES  <p>72" EXTENSION CORD PART# DLSEC-72</p> <p>120" EXTENSION CORD PART# DLSEC-120</p>	PRE-MOUNTING PLATE FOR NEW CONSTRUCTION APPLICATIONS AVAILABLE. PLEASE CONTACT ETLIN-DANIELS.  PART NO#: DLSS6-MP
---	---	---	--	---

ORDERING INFORMATION - DLSW SERIES

SERIES	IP RATING	SHAPE	SIZE	WATTAGE	VOLTAGE	COLOR TEMPERATURE	DIMMABLE	COLOR	LENS	TRIM
E.G. DLS	W	S	6	12	1	3	D	BN	F	F
DLS - DOWNLIGHT SLIM	W - WET LOCATION IP65	S - SQUARE	6 - 6"	12 - 12W	1 - 120V	3 - 3000K	D - TRIAC	BN - BRUSHED NICKEL	F - FROSTED	F - FIXED

IF PRE-MOUNTING PLATE IS REQUIRED FOR NEW CONSTRUCTION PROJECTS, PLEASE QUOTE: PART NO#: DLSS6-MP WHEN ORDERING.

Head Office - 1850 Wilson Ave. · Toronto, ON · M9M 1A1 · Tel: 416.741.7336 · Fax: 416.741.9104

Toll Free: in Canada. 1.800.661.9610 · in USA. 1.888.762.5384 (SOCKETS4U)

www.etlin-daniels.com · For sales/service questions - sales@etlin.com