

PRODUCT CODE: RTFFR56-151-CD-WH

6 INCH APERTURE DISK LIGHT SURFACE MOUNT - 3CCT

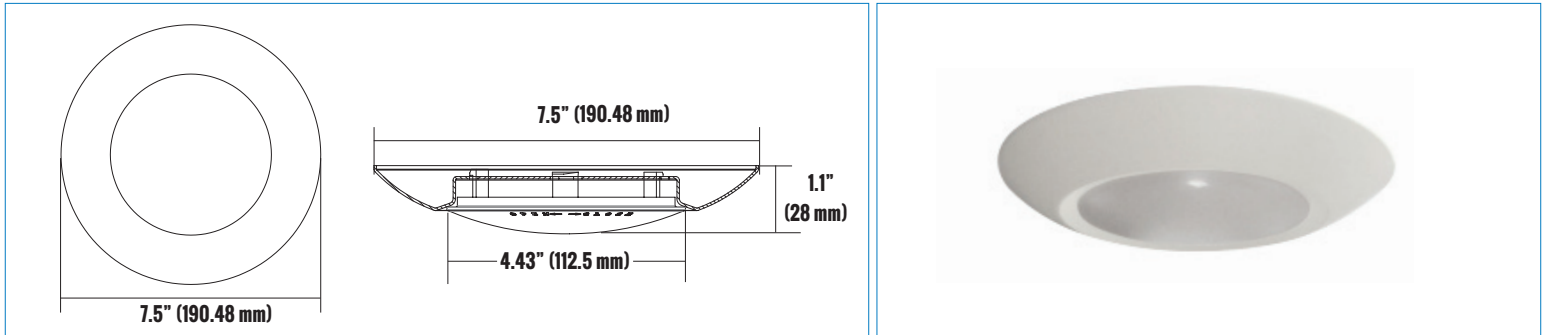

PRODUCT DESCRIPTION

The Etlin-Daniels Low profile LED Surface Mount Disk Light RTFFR56-151-CD-WH offers the latest in both energy savings and ease of installation. At only 1.1" in depth and 7.5 inches in width, and with its easily removable translucent white polycarbonate diffuser, the RTFFR series provides a 105° beam pattern of glare free, energy efficient illumination.

The keyless slot rear mounting profile allows for a simple and quick installation in minutes. Triac dimmable and wet location rated, indoor applications include a wide range from closets and storage areas, basements, stairwells, to general lighting in small rooms. Take advantage of the 3CCT switch to choose between 3000K, 4000K and 5000K. And, for extra energy savings, take advantage of the available Triac dimming.

FEATURES

- Indoor LED Light Source
- Surface mount, low profile - 1.1" housing with 105° translucent polycarbonate diffuser
- Keyless slot mounting to j-boxes
- Wet location and IC rated
- Triac Dimmable
- 3CCT - 3000K, 4000K, 5000K
- 5 year warranty
- L70 - 50,000 hours
- Energy Star Certified

PRODUCT SPECIFICATIONS (OPTICAL DATA)

LED TYPE	LED QTY	SYSTEM EFFICACY	LUMENS	COLOR TEMPERATURE	BEAM ANGLE	CRI	SYSTEM EFFICIENCY	VOLTAGE	POWER FREQ.	POWER EFFICIENCY	POWER FACTOR	HARMONIC DISTORTION
DOB	28 CHIPS	66.7 LM/W	949 LM 1086 LM 983 LM	3000K 4000K 5000K	120°	>80CRI	>65%	120V	60HZ	>65%	>0.9	<50%

PRODUCT SPECIFICATIONS (ELECTRICAL DATA)

PRODUCT SPECIFICATIONS

WATTAGE	FIXTURE MATERIAL	INGRESS PROTECT	LIFE SPAN	STORAGE TEMP	OPERATING TEMP	PRODUCT DIMENSIONS	CARTON SIZE
15W	ALUMINUM /PLASTIC	IP44	>50,000 HOURS	-5°C - 30°C - -4°F - 22°F	-20°C - 40°C - -4°F - 104°F	7.5 X 1.1 INCHES (190.48 X 28 MM)	16.38 X 9 X 16.38 INCHES (416 X 229 X 416 MM)

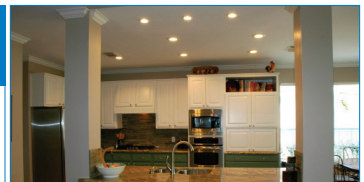

ADDITIONAL INFORMATION

INSTALLATION METHOD

SURFACE MOUNT

FIXTURE COLOR

WHITE ALUMINUM/
POLYCARBONATE DIFFUSER

CONTROL TYPE

TRIAC DIMMABLE

CATALOG #		TYPE
PROJECT		DATE
PREPARED BY		

PRODUCT CODE: RTFFR56-151-CD-WH
6 INCH APERTURE DISK LIGHT SURFACE MOUNT - 3CCT

LUMINAIRE PHOTOMETRIC (TEST REPORT) - 3000K
ILLUMINANCE (AT A DISTANCE) - FLUX OUT: 656.7 LM

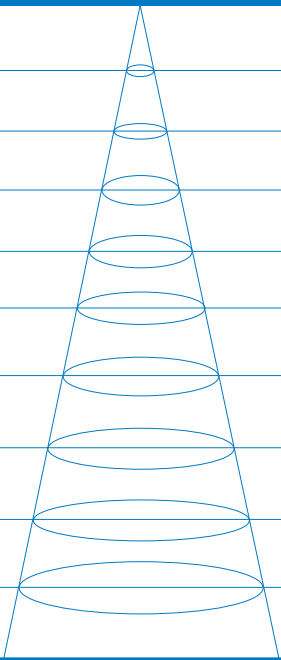
3.28FT 1M	110.3, 343.7 LX		8.99 FT 274.17 CM
6.56FT 2M	27.59, 85.93 LX		17.99 FT 548.34 CM
9.84FT 3M	12.26, 38.19 LX		26.99 FT 822.51 CM
13.12FT 4M	6.896, 21.48 LX		35.98 FT 1096.67 CM
16.40FT 5M	4.414, 13.75 LX		44.98 FT 1370.84 CM
19.69FT 6M	3.065, 9.548 LX		53.97 FT 1645.01 CM
22.97FT 7M	2.252, 7.015 LX		62.97 FT 1919.18 CM
26.25FT 8M	1.724, 5.371 LX		71.96 FT 2193.35 CM
29.52FT 9M	1.362, 4.243 LX		80.95 FT 2467.52 CM
32.80FT 10M	1.103, 3.437 LX		89.95 FT 2741.68 CM
HT	EAVG/EMAX	ANGLE: 107.78 DEG	DIA

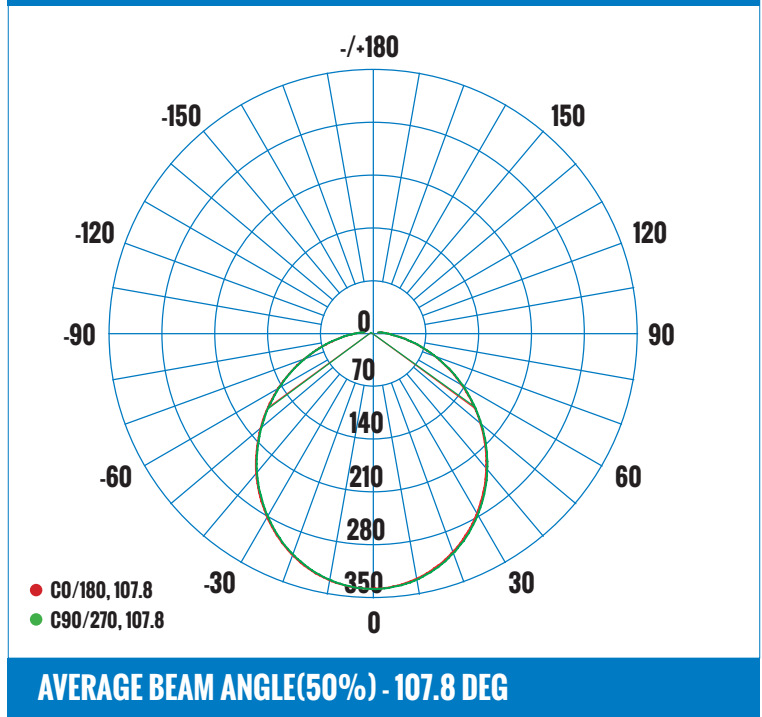
LUMINOUS INTENSITY DISTRIBUTION DIAGRAM

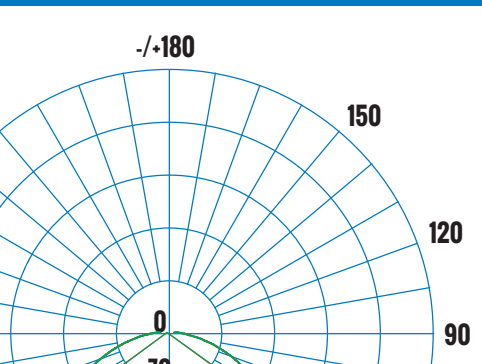
LUMINAIRE PHOTOMETRIC (TEST REPORT) - 4000K
ILLUMINANCE (AT A DISTANCE) - FLUX OUT: 751.3 LM

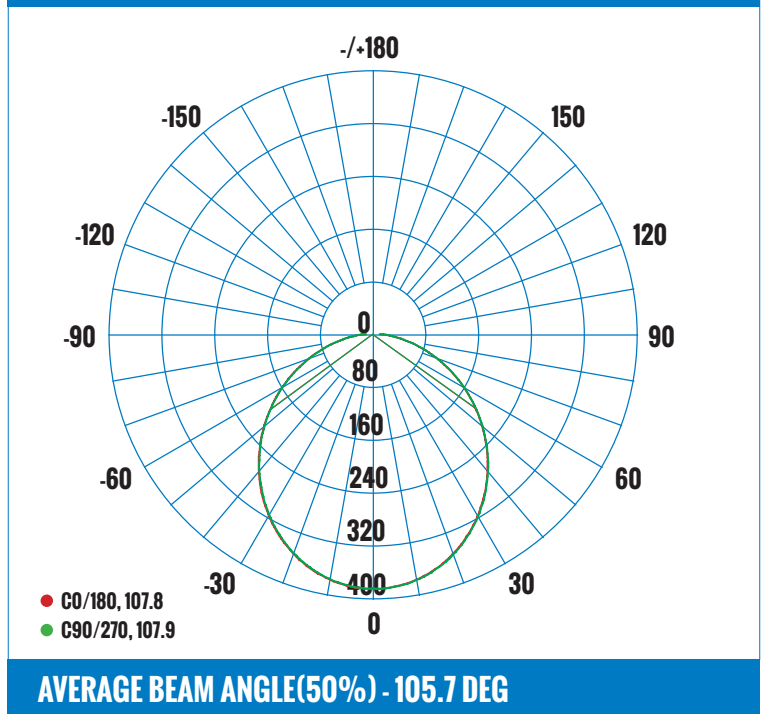
3.28FT 1M	126.2, 393.2 LX		9.00 FT 274.47 CM
6.56FT 2M	31.56, 98.31 LX		17.31 FT 548.94 CM
9.84FT 3M	14.03, 43.69 LX		18.00 FT 823.41 CM
13.12FT 4M	7.890, 24.58 LX		36.01 FT 1097.88 CM
16.40FT 5M	5.050, 15.73 LX		45.03 FT 1372.35 CM
19.69FT 6M	3.507, 10.92 LX		54.03 FT 1646.82 CM
22.97FT 7M	2.576, 8.025 LX		63.03FT 1921.29 CM
26.25FT 8M	1.973, 6.144 LX		72.04FT 2195.76 CM
29.52FT 9M	1.559, 4.855 LX		81.04 FT 2470.23 CM
32.80FT 10M	1.262, 3.932 LX		90.05FT 2744.70 CM
HT	EAVG/EMAX	ANGLE: 107.84DEG	DIA

LUMINOUS INTENSITY DISTRIBUTION DIAGRAM

CATALOG #		TYPE
PROJECT		DATE
PREPARED BY		

PRODUCT CODE: RTFFR56-151-CD-WH

6 INCH APERTURE DISK LIGHT SURFACE MOUNT - 3CCT



LUMINAIRE PHOTOMETRIC (TEST REPORT) - 5000K

ILLUMINANCE (AT A DISTANCE) - FLUX OUT: 695.5LM

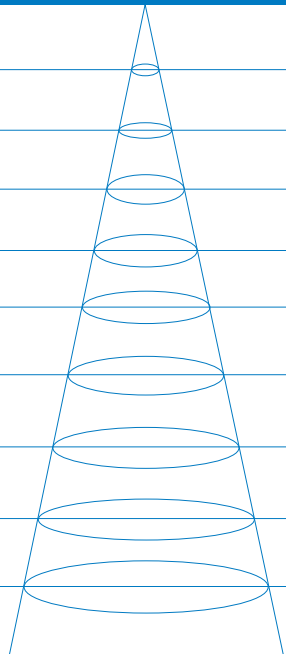
3.28FT 1M	108.6, 355.4 LX		9.03 FT 275.28 CM
6.56FT 2M	27.14, 88.85 LX		18.06 FT 550.55 CM
9.84FT 3M	12.06, 39.49 LX		27.09 FT 825.83 CM
13.12FT 4M	6.784, 22.21 LX		36.13 FT 1101.11 CM
16.40FT 5M	4.342, 14.22 LX		45.16 FT 1376.38 CM
19.69FT 6M	3.015, 9.872 LX		51.93 FT 1651.66 CM
22.97FT 7M	2.215, 7.253 LX		54.18 FT 1926.94 CM
26.25FT 8M	1.696, 5.553 LX		72.25 FT 2202.21 CM
29.52FT 9M	1.340, 4.388 LX		81.28 FT 2477.49 CM
32.80FT 10M	1.086, 3.554 LX		90.32FT 2752.77 CM
HT	EAVG/EMAX	ANGLE: 108.00DEG	DIA

LUMINOUS INTENSITY DISTRIBUTION DIAGRAM

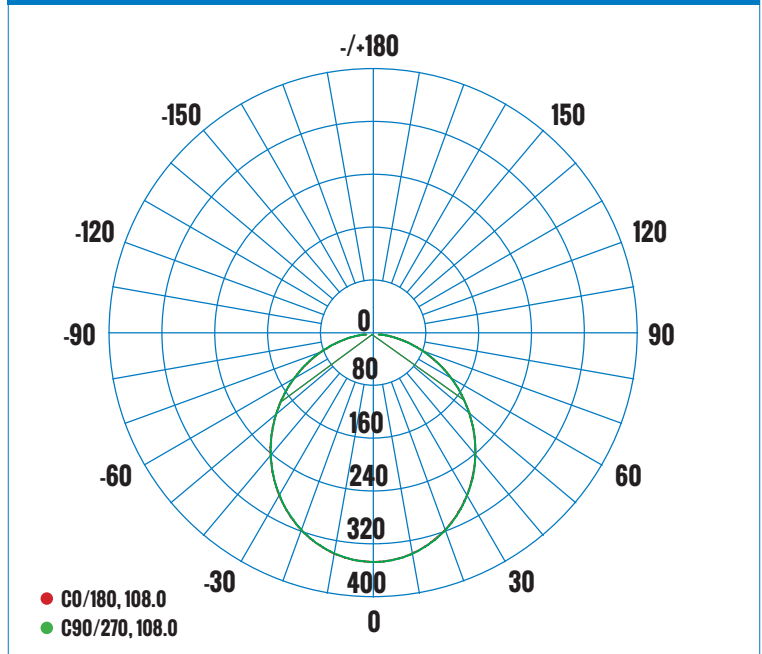

AVERAGE BEAM ANGLE(50%) - 108.0 DEG

CERTIFICATIONS



CAN ICES-005 (B) / NMB-005 (B)

DRIVER/LED CHIP



ORDERING INFORMATION - RTFFR SERIES

SHAPE	STYLE	SIZE	WATTAGE	VOLTAGE	COLOR TEMPERATURE	DIMMABLE	FINISH
E.G. R	TFFR	56	15	1	C	D	WH
R - ROUND	TFFR - THIN FLUSH FIXTURE REVEAL	56 - 6"	15- 15W	1 - 120V	C - CHANGEABLE COLOR TEMPERATURE 3000K, 4000K, 5000K	D - TRIAC	WH - WHITE

Head Office - 1850 Wilson Ave. · Toronto, ON · M9M 1A1 · Tel: 416.741.7336 · Fax: 416.741.9104

Toll Free: in Canada. 1.800.661.9610 · in USA. 1.888.762.5384 (SOCKETS4U)

www.etlin-daniels.com · For sales/service questions - sales@etlin.com